

multimec® basic switch modules

Through-hole Versions							
3A		3C		3E	3F		
For 1A/1B/1M/1ZA/1ZB	w/LED for 1C/1H			For 3E actuators/Varimec	For 1D/1K/1N/1P/1S/1T/1U/1V/1WA/1WD/1WG/1WP/1X/1ZC/1GA/1GC	w/LED for 1D/1E/1F/1N/1Q/1R/1S/1X	w/LED for 1K/1KB/1KC/1T/1U/1V/1WA/1WD/1WP
Standard Versions							
3ATL6 3ATH9	3ATL600/20/40/80	3CTL6/3CTL9 3CTH9	3ETLXX-H* 3ETHXX-H*	3FTL6 3FTH9	3FTL600/20/40/60/80/ 2040/8020/8040	3FTL623/45/88	
* 3E available in 6 standard heights: 08.0, 09.5, 10.4, 11.0, 12.0, 15.0 mm. Other heights between 08.0 and 15.0 mm are available upon request.							
Specials: Gold contacts, quiet version and actuation force other than 3.0N							

Surface Mount Versions				Right Angle Versions			
3A	3C	3E	3F	3C	3E	3F	3F w/LED
For 1A/1B/1M/1ZA/1ZB		For 3E actuators/Varimec	For 1D/1K/1N/1P/1S/1T/1U/1V/1WA/1WD/1WP/1X/1ZC/1GA/1GC		For 3E actuators/Varimec	For 1D/1K/1N/1P/1S/1T/1U/1V/1W/1WA/1WD/1WP/1X/1ZC/1GA/1GC	For 1D/1E/1F/1N/1Q/1R/1S/1X
Standard Versions				Standard Versions			
3ASH9/3ASH9R	3CSH9/3CSH9R	3ESH9/3ESH9R	3FSH9/3FSH9R	3CTL6RAS	3ETXX-X.XRAS	3FTL6RAS	3FTL600/20/40/60/80/ 2040/8020/8040RAS

Co-planarity = ≤ 0.05

DIMENSIONS (mm) Unless otherwise specified, all tolerances ± 0.2

multimec® Cross Section

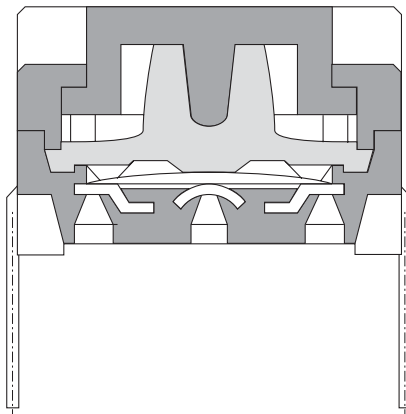

For updates of products and/or changes of specifications please see www.mec.dk

multimec® 3F + 1GA/1GC

Technical Data

- through-hole or SMD
- 50mA/24VDC
- single pole/momentary
- 10.000.000 operations life time
- IP67 sealing
- temperature range:
low temp: -40/+115°C
high temp: -40/+160°C



Dimensions (through-hole)

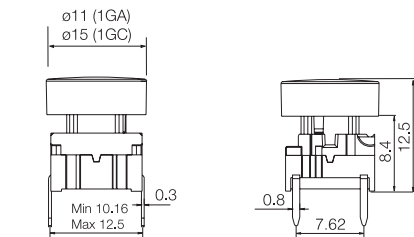

PCB layout

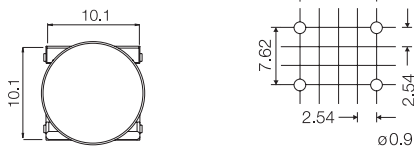

Dimensions (w/extender)

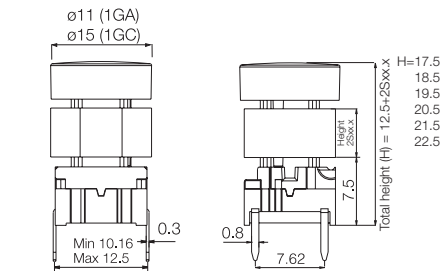

PCB layout

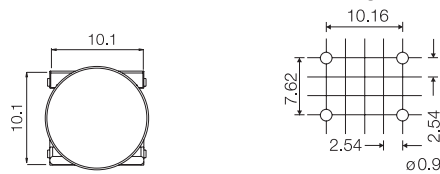

Dimensions (SMD)

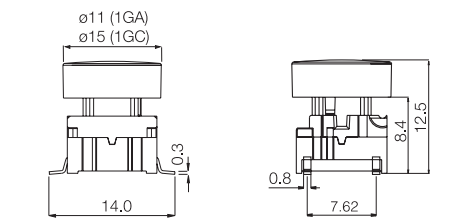

PCB layout

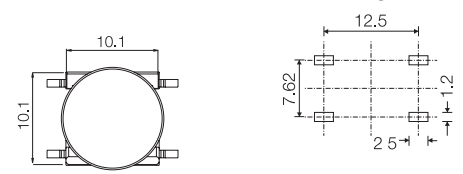

How to order

3 F

Switch



Mounting

T through-hole
S surface mount



L 6 low temp.

H 9 high temp.

+

1 G A 0 9

Cap black



1 G C 0 9

Cap black



+

2 S 0 9 - . 0

Extender black



(Optional)
Adds 5-10 mm
to total height.

Height

05.0

06.0

07.0

08.0

09.0

10.0

Keycap	Variable Extender	H (height) mm	Example
1GA/1GC		12.5	H 1
1GA/1GC	2S09-05.0	17.5	H 2
	2S09-06.0	18.5	
	2S09-07.0	19.5	
	2S09-08.0	20.5	
	2S09-09.0	21.5	
	2S09-10.0	22.5	H 3

H = Overall height

Overall heights below 12.5 mm - Please see Multimec® versions 3C and 3E.

All 2S09 extenders are stackable giving the possibility to match most overall heights.

A = We recommend you to allocate enough space for travel of the foil and leave the area free from adhesive.

Switch travel = 1 mm.

H = We recommend you to calculate this dimension from the top of the PCB to the inner top of the panel.

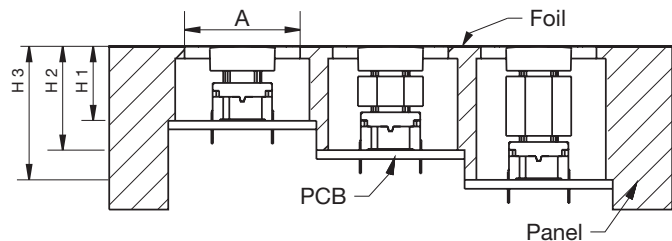

Ordering example: 3FTL6 + 1GA09 or 3FTL6 + 2S09-07.0 + 1GC09

For updates of products and/or changes of specifications please see www.mec.dk

multimec[®] 3F + 1N

Technical Data

- through-hole or SMD
- 50mA/24VDC
- single pole/momentary
- 10.000.000 operations life time
- IP67 sealing
- temperature range:
low temp: -40/+115°C
high temp: -40/+160°C



Dimensions (through-hole)

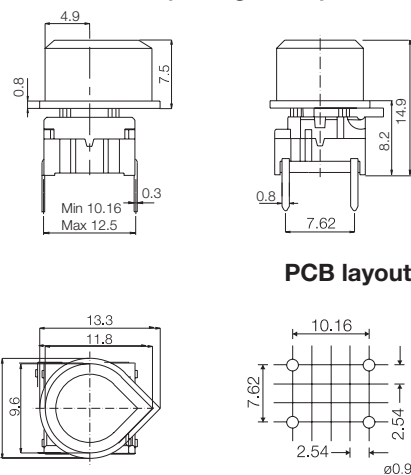

Dimensions (w/LED)

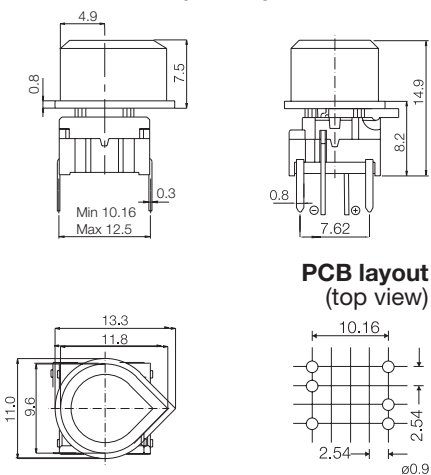

Dimensions (SMD)

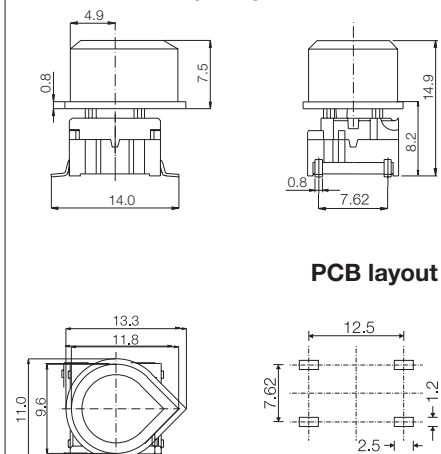

8 different position options

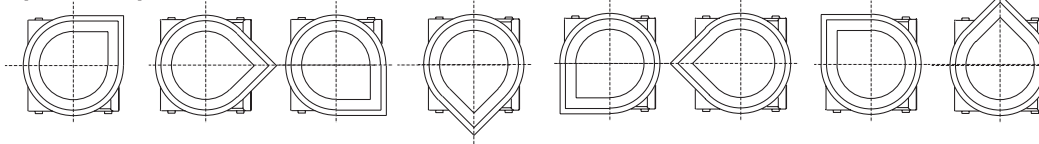

How to order

3 F	<input type="checkbox"/>	<input type="checkbox"/>	+	1 N	<input type="checkbox"/>
Switch	Mounting T through-hole S surface mount	L 6 low temp. H 9 high temp.		Cap 	00 blue 03 grey 04 yellow 08 red 09 black

3 F	T	<input type="checkbox"/>	<input type="checkbox"/>	+	1 N	<input type="checkbox"/>
Switch	Mounting T through-hole	L 6 low temp. H 9 high temp.	LED 00 blue 20 green 40 yellow 60 white 80 red 2040 green/yellow 8020 red/green 8040 red/yellow		Cap 	10 frosted blue 12 frosted green 14 frosted yellow 16 frosted white 18 frosted red

Keycaps shown on this page can also be used on
illume[™] switch 4F - see page 13

Ordering example: 3FTL6 + 1N09 or 3FTL680 + 1N18

For updates of products and/or changes of specifications please see www.mec.dk

multimec® 3F + 1WA/1WD/1WP

Technical Data

- through-hole or SMD
- 50mA/24VDC
- single pole/momentary
- 10.000.000 operations life time
- IP67 sealing
- temperature range:
low temp: -40/+115°C
high temp: -40/+160°C



Dimensions (through-hole) 1WA

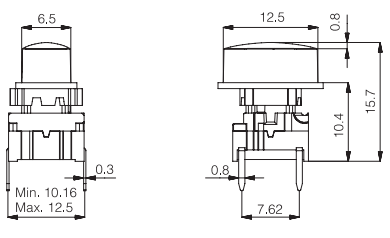

PCB layout

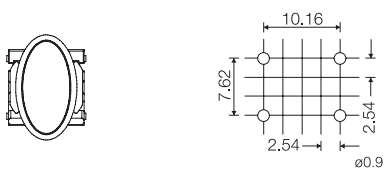

Dimensions (w/LED) 1WD

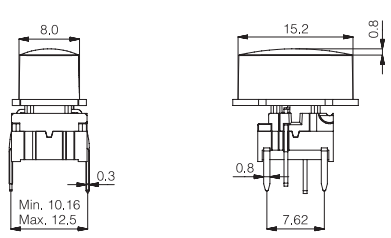

PCB layout (top view)

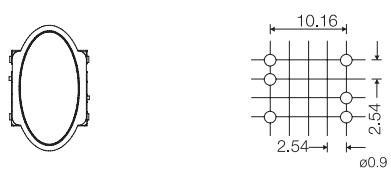

Dimensions (SMD) 1WP

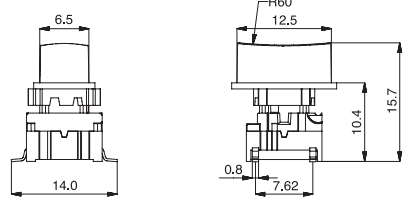

PCB layout

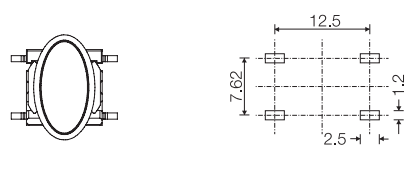

8 different position options

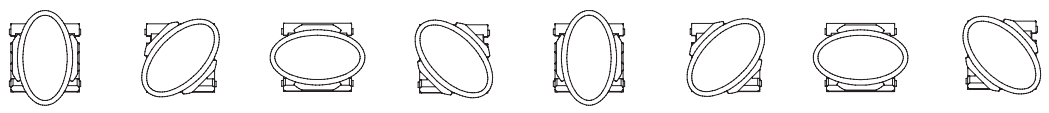

How to order

3 F	<input type="checkbox"/>	<input type="checkbox"/>	+	<input type="checkbox"/>	<input type="checkbox"/>
Switch	Mounting	L 6 low temp. H 9 high temp.		Cap	00 blue 03 grey 08 red 09 black 30 ultra blue 40 pigeon blue 42 aqua blue 53 metal light grey 57 metal dark grey
	T through-hole S surface mount			1WA 1WD 1WP	

3 F	T	<input type="checkbox"/>	<input type="checkbox"/>	+	<input type="checkbox"/>	<input type="checkbox"/>
Switch	Mounting	L 6 low temp. H 9 high temp.	LED		Cap	16 frosted white
	T through-hole		23 green 45 yellow 88 red		1WA 1WD 1WP	

Keycaps shown on this page can also be used on **illumecc™ switch 4F** - see page 13

Ordering example: 3FTL6 + 1WA09 or 3FTL680 + 1WP16

For updates of products and/or changes of specifications please see www.mec.dk

multimec® 3F + 1X

Technical Data

- through-hole or SMD
- 50mA/24VDC
- single pole/momentary
- 10.000.000 operations life time
- IP67 sealing
- temperature range:
 - low temp: -40/+115°C
 - high temp: -40/+160°C



Dimensions (through-hole)

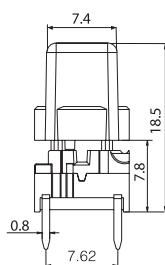
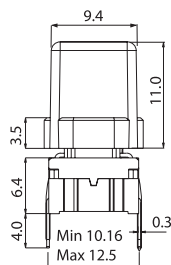

PCB layout

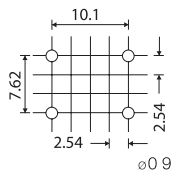
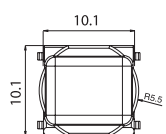

Dimensions (w/LED)

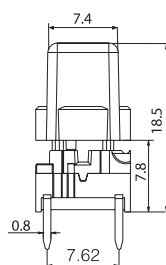
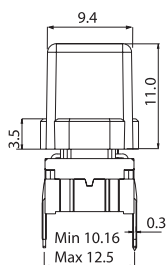

PCB layout (top view)

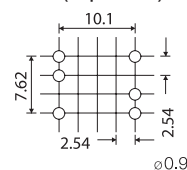
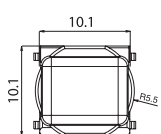

Dimensions (SMD)

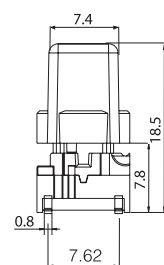
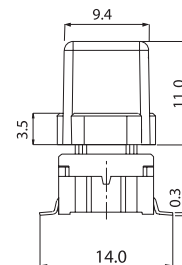

PCB layout

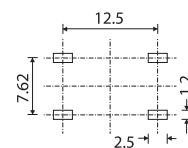
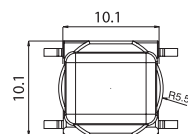

How to order

3 F

Switch



Mounting

T through-hole
S surface mount



L 6 low temp.
H 9 high temp.

+

1 X

Cap



00 blue
02 green
03 grey
04 yellow
06 white
08 red
09 black

30 ultra blue
40 dusty blue
42 aqua blue
32 mint green
33 tele grey
34 melon
38 noble red

50 metal dark blue
53 metal light grey
57 metal dark grey
58 metal bordeaux

3 F

Switch



Mounting

T through-hole



L 6 low temp.
H 9 high temp.

+

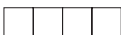

LED
00 blue
20 green
40 yellow
60 white
80 red
2040 green/yellow
8020 red/green
8040 red/yellow

1 X

Cap



11 transparent
16 frosted white

Keycaps shown on this page can also be used on **illume™ switch 4F** - see page 13

Ordering example: 3FTL6 + 1X09 or 3FTL680 + 1X11

For updates of products and/or changes of specifications please see www.mec.dk

multimec[®] Aquamec[™]

Specifications switches: Specifications Sealing Boot:

- through-hole or SMD
- 50mA/24VDC
- single pole/momentary
- 10.000.000 operations life time
- IP67 sealing
- temperature range:
low temp: -40/+115°C
high temp: -40/+160°C

- Operating temperature: -40/+85°C
- IP67 sealing
- sealing life time: 2.000.000 operations
- material: silicone

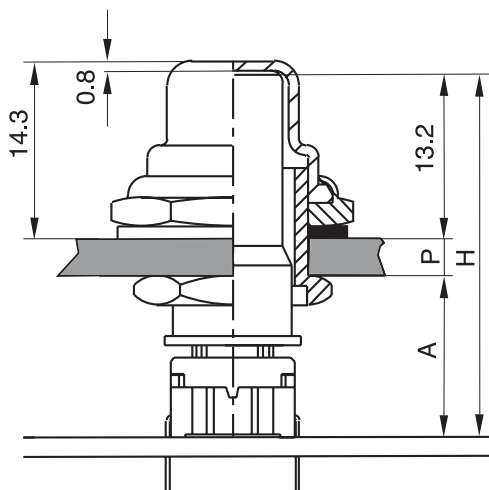

$$H = A + P + 13.2$$

This leaves nominal 0.3 mm clearance between the top of the cap and the inner side of the sealing boot to accomplish assembly tolerances. **A** can be chosen between 10 -13 mm, we recommend 10 mm to reduce building height and optimize cap guidance.

A	P	CAP	H	BUSHING
10.0	1.0	AQCXX-24.2	24.2	AQN-0.5
10.0	2.0	AQCXX-25.2	25.2	AQN-0.5
10.0	3.0	AQCXX-26.2	26.2	AQN-2.5
10.0	4.0	AQCXX-27.2	27.2	AQN-2.5

Cap is available in black (09) or transparent (11).

The dimension H is the overall height of the switch+cap.
Bushing AQN-0.5 accepts panel thickness (P) 0.5-2.5 mm.
Bushing AQN-2.5 accepts panel thickness (P) 2.5-4.0 mm.
Panel cut out \varnothing 12.0 \pm 0.2.

How to order

3 F	<input type="checkbox"/>	<input type="checkbox"/>	+	AQN	-	<input type="checkbox"/>	.	<input type="checkbox"/>	+	AQC	<input type="checkbox"/>	-	<input type="checkbox"/>	.	<input type="checkbox"/>	+	AQB01	<input type="checkbox"/>	<input type="checkbox"/>
Switch	Mounting	L 6 low temp. H 9 high temp.		Bushing	Panel	0.5 2.5				Cap	09 black 11 transparent		Overall Height	24.2 25.2 26.2 27.2			Sealing boot, incl. sealing ring	09 black 11 transparent	

3 F	T	<input type="checkbox"/>	<input type="checkbox"/>	+	AQN	-	<input type="checkbox"/>	.	<input type="checkbox"/>	+	AQC	<input type="checkbox"/>	-	<input type="checkbox"/>	.	<input type="checkbox"/>	+	AQB01	<input type="checkbox"/>	<input type="checkbox"/>
Switch	Mounting	L 6 low temp. H 9 high temp.		Bushing	Panel	0.5 2.5				Cap	11 transparent		Overall Height	24.2 25.2 26.2 27.2			Sealing boot, incl. sealing ring	11 transparent		
					LED															
					00	blue														
					20	green														
					40	yellow														
					60	white														
					80	red														
					2040	green/yellow														
					8020	red/green														
					8040	red/yellow														

Keycaps shown on this page can also be used on **illumec[™] switch 4F** - see page 13

Ordering example: AQB0109 + AQC09-27.2 + AQN-2.5 + 3FTL6

For updates of products and/or changes of specifications please see www.mec.dk